



# MAIN ELECTRONIC SUPPLIES LTD.

Electronic Parts Distributor to the Service Industry

4554 Main Street Vancouver B.C. Canada V5V 3R5

Phone 604-872-0267 Fax 604-872-0268

## Ceramic Cartridges



# ASTATIC PHONOGRAPH CARTRIDGES

Cartridge Number	Used in or Replacement for	Figure	ASTATIC Needle	Element	Volts Output	FREQ. RANGE	SPEED
12u	(m) Ast.orig.-Adm.,Phil.,VM	A1	N4-3s*	Crystal	4.0**	1oz.	50-5000 78
13t	(s) Ast.orig.-Moto.,Phil.,Zen.	A3	PL(.7s-.7s)	Ceramic	0.65	7gr.	20-15K 33-45
13tb	(s) Ast.orig.-Emer.,Phil.,Zen.	A3,4	PL(.7s-.7s)	Ceramic	0.65	7gr.	20-15K 33-45
13tbx	(s) Ast.orig.-Moto.,Phil.,Magn.	A3,4	PL(.7d-.7s)	Ceramic	0.65	7gr.	20-15K 33-45
13tx	(s) Ast.orig.-Moto.,Phil.,Zen.	A3	PL(.7d-.7s)	Ceramic	0.65	7gr.	20-15K 33-45
16	(m) Ast.orig.-VM	A5	N4-2s*	Crystal	3.5	10gr.	50-5000 33-45
17	(s) Ast.orig.-Adm.,G.E.,VM	A6	N41(.7s-.7s)	Ceramic	350MV	3gr.	20-20K 33-45
17d	(s) Ast.orig.-Adm.,G.E.,VM,Zen.	A6	N41-sd(.7d-.7s)	Ceramic	350MV	3gr.	20-20K 33-45
51-1	(m) Ast.orig.RCA	A11	N29-1s	Ceramic	0.7	8gr.	30-15K 33-45
51-2	(m) Ast.orig.-Adm.,RCA	A11	N29-2s	Ceramic	0.7	8gr.	30-10K 33-45
62-1	(m) Ast.orig.-RCA	A13	N27-1s	Crystal	3.0	10gr.	50-5000 33-45
64ts	(m) Ast.orig.-VM	A15	N8-1s & 3s	Crystal	3.0	8gr.	50-11K ALL
70ts	(s) Ast.orig.-VM	A16	N8-1s & 3s	Crystal	2.0	8gr.	50-10K ALL
76tsb	(s) Ast.orig.-Airl.,Phil.	A18	N8-7s & 3s	Crystal	2.0	8gr.	50-10K ALL
77-7d	(st) Ast.orig.-Borg War	A35	PL(.7d)	HC Cer.	1.0	9gr.	40-10K 33-45
79	(m) Ast.orig.Audio Visual	A19	PL(1s 1s)	Ceramic	1.1	5gr.	30-15K 33-45
79d	(m) Ast.orig.Audio Visual	A19	PL(1d 1s)	Ceramic	1.1	5gr.	30-15K 33-45
80ts	(s) Ast.orig.-Arv.,Phonola,MV	A16	N7-7s & N8-3s	Crystal	0.8	6gr.	50-15K ALL
81t	(m) Ast.orig.-pop/Vis. equip.	A20	PL(1s 1s)	Ceramic	1.0	8gr.	30-15K 33-45
81tb	(m) Ast.orig.-pop/Vis. equip.	A20,21	PL(1s 1s)	Ceramic	1.0	8gr.	30-15K 33-45
81ts	(m) Ast.orig.-pop/Vis. equip.	A20	PL(1d 1s)	Ceramic	1.0	8gr.	30-15K 33-45
83d	(m) Ast.orig.	A20	PL(.7d-.7d)	Ceramic	1.5	8gr.	40-10K 33-45
86tsb	(s) Ast.orig.-Adm.,Magn.	A18	N7-7s & N8-3s	Crystal	0.8	6gr.	50-15K ALL
87T1	(m) Ast.orig.-Dukane 563-93	A20	PL(1s-1s)	Ceramic	1.5	10gr.	40-10K 33-45
87T1A	(m) Ast.orig.-Dukane 563-134	A20	PL(1s-1s)	Ceramic	1.5	10gr.	40-10K 33-45
89	(m) Ast.orig.-Audio Visual	A20	PL(1s 1s)	Ceramic	1.1	5gr.	30-15K 33-45
89d	(m) Ast.orig.Audio Visual	A20	PL(1d 1s)	Ceramic	1.1	5gr.	30-15K 33-45
89-1	(m) Ast.orig.-RCA(sil. fill.)	A20	PL(1s)	Ceramic	1.3	6gr.	30-15K 33-45
89t	(m) Ast.orig.pop/Vis. equip.	A20	PL(1s 1s)	Spcl.Cer.	1.3	6gr.	30-15K 33-45
89tb	(m) Ast.orig.-pop/Vis. equip.	A20,21	PL(1s 1s)	Spcl.Cer.	1.3	6gr.	30-15K 33-45
89tx	(m) Ast.orig.-pop/Vis. equip.	A20	PL(1d 1s)	Spcl.Cer.	1.3	6gr.	30-15K 33-45
93tx	(m) EV56d (orange)	G2	PL(1d 1s)	Ceramic	1.5	8gr.	30-15K 33-45
97-1	(m) Zen.15222 (green)	G3	PL(1s)	Coil		6gr.	30-10K 33-45
97-2	(m) Zen. 15780 (red & grn.)	G3	PL(2s)	Coil		6gr.	30-8000 33-45
120	(m) Ast.orig.-Phil.,VM	A22	N8-1s & 3s	Crystal	3.0	8gr.	30-11K ALL
133	(s) Ast.orig.-Adm.,Arv.,Zen.	A23	N50(.7s-.7s)	Ceramic	0.5	4-6gr.	20-15K 33-45
133d	(s) Ast.orig.-Adm.,Airl.,Phi I.	A23	N50-sd(.7d-.7s)	Ceramic	0.5	4-6gr.	20-15K 33-45
133dd	(s) Ast.orig.-Wuritzer	A23	N51-d .7d .7d	Ceramic	0.5	6gr.	40-15K 33-45
139d	(s) Ast.orig.-Phil.	A23	N50-sd(.7d-.7s)	HC Cer.	275MV	4-6gr.	20-15K 33-45
140	(s) Ast.orig.-Adm. to Zen. (A-Z)	A6	N60(.7s-.7s)	Crystal	1.0	6gr.	30-15K 33-45
140d	(s) Ast.orig.-Adm. to Zen. (A-Z)	A6	N60-sd(.7d-.7s)	Crystal	1.0	6gr.	30-15K 33-45
142	(s) Ast.orig.-Adm. to Zen. (A-Z)	A6	N72(.7s-.7s)	Crystal	2.0	8gr.	30-10K 33-45
142d	(s) Ast.orig.-Adm. to Zen. (A-Z)	A6	N72-sd(.7d-.7s)	Crystal	2.0	8gr.	30-10K 33-45
142nd	(s) Ast.orig.-G.E. (retract)	A6	N72-sd(.7d-.7s)	Crystal	2.0	8gr.	30-10K 33-45
146	(m) Ast.orig.-Adm. to Zen. (A-Z)	A6	N62(1s 1s)	Crystal	3.0	8gr.	30-10K 33-45
146-1	(m) Ast.orig.-G.E., Sears	A24	N76-1s	Crystal	2.7	8gr.	30-10K 33-45
146-7	(m) Ast.orig.-RCA 123489	A24	N76-7s	Crystal	2.7	8gr.	30-10K 33-45
153d	(s) Adm.,Syl.	A23	N56-sd(.7d-.7s)	Ceramic	350MV	4gr.	20-15K 33-45
155d	(s) Ast.orig.-Morse Electroph.	A23	N58-sd(.7d-.7s)	Ceramic	480MV	4-6gr.	20-15K 33-45
157d	(s) Adm.	A23	N56-sd(.7d-.7s)	HC Cer.	100MV	4gr.	20-15K 33-45
163d	(s) Ast.orig.-Magn. 560350-1	A25	N2-sd(.7d-.7s)	HC Cer.	160MV	3gr.	20-20K 33-45
165d	(s) Ast.orig.-Magn. 560355-1	A25	N63-sd(.7d-.7s)	HC Cer.	250MV	3gr.	20-20K 33-45
181d	(s) Ast.orig.-Sylv.	A26	N64-sd(.7d-.7s)	HC Cer.	110MV	2-4gr.	20-20K 33-45
192	(m) Ast.orig.-Sears	A6	N63(1s 1s)	Crystal	2.7	8gr.	30-10K 33-45
195d	(s) Ast.orig.-Magn. 560345-1	A25	N2-sd(.7d-.7s)	Ceramic	250MV	3gr.	20-20K 33-45
197d	(s) Ast.orig.-Magn. 560347-1	A25	N410-7d	Ceramic	160MV	3gr.	20-20K 33-45
275d	(s) Ast.orig.-Sears	A29	N74-sd(.7d-.7s)	HC Cer.	290MV	3gr.	20-20K 33-45
310-2	(m) Ast.orig.-Conv./many Mfgs.	A31	N6-2s	Crystal	3.0	8gr.	30-11K 33-45
314ts	(m) Ast.orig.-Airl.,RCA	A33	N8-1s & 3s	Crystal	3.0	8gr.	30-11K ALL
327d	(s) RCA 135272	G44	N577-7d(.7d)	HC Cer.	300MV	5gr.	20-20K 33-45
340	(m) Vaco sn-55	G6	N8-2s	Crystal	3.0	8gr.	30-11K ALL
348	(s) RCA 115059	G7	N76-7s	Crystal	2.0	8gr.	30-10K 33-45

## LEGEND

(ed) — Elliptical—33 $\frac{1}{3}$ (stereo)	D & X — Natural Diamond	* — Needle not included with Cartridge
(n) — New since C-80 Cartridge Catalog	T — Turnover Cartridge	-1 — 1 Mil.33 $\frac{1}{3}$ -45 RPM
(qd) — 4-Channel	TB — Turnover Cartridge with Bracket	-2 — 2 Mil.33 $\frac{1}{3}$ -45-78 RPM
(s) — Stereo	TX — Turnover Cartridge with Formed Yoke	-3 — 3 Mil.78 RPM
(m) — Monaural	TS — Turnover Cartridge with Rounded Spindle	-5 — 0.5 Mil.—33 $\frac{1}{3}$ (Stereo)
S — Precision Polished Synthetic; Jewel Tip	PL — Plug-in Cartridge	-6 — 0.6 Mil.—33 $\frac{1}{3}$ (Stereo)
Td — Truncated		-7 — 0.7 Mil.—33 $\frac{1}{3}$ -45 (Stereo or Monaural)

For Astatic Models Not Listed Here Refer to pages 5, 6, and 7.

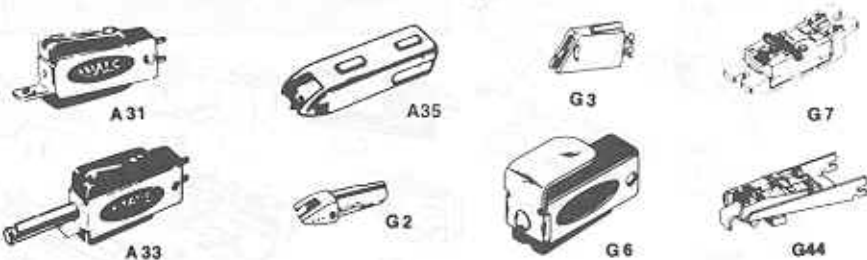
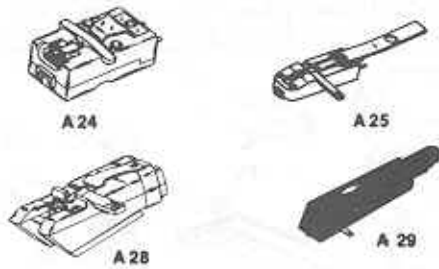
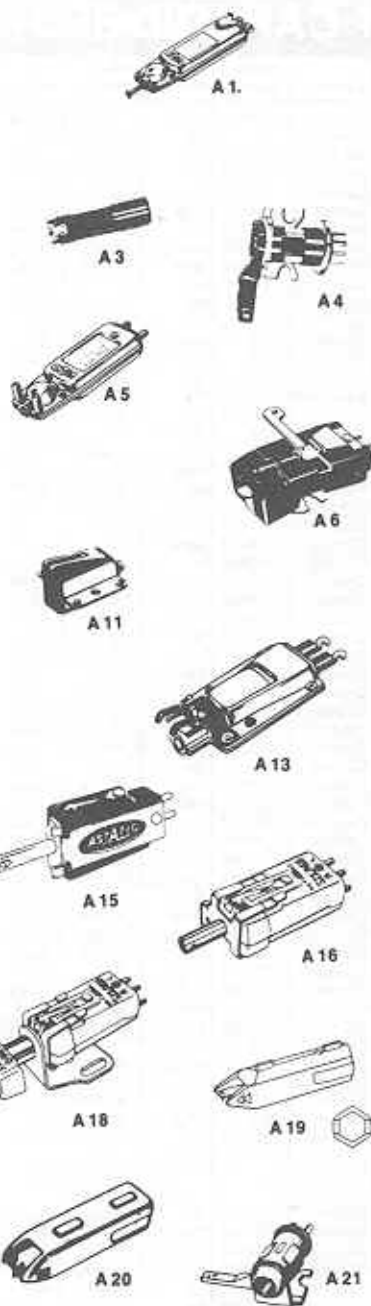

# ASTATIC PHONOGRAPH CARTRIDGES

Cartridge Number	Used in or Replacement for	Figure	ASTATIC Needle	Element	Volts Output	Pressure	FREQ. RANGE	SPEED
349d	(s) G.E. c-500	G8	N74-sd(7d .7s)	HC Cer.	100MV	4gr	30-20K	33-45
351d	(s) GE c650	G9	N74-sd(7d .7s)	Ceramic	0.5	4gr	30-20K	33-45
353	(s) RCA 115276	G10	N83(.7s .7s)	HC Cer.	175MV	3gr	20-20K	33-45
355	(s) RCA 115302; 117330	G10	N83(.7s .7s)	HC Cer.	250MV	3gr	20-20K	33-45
357d	(s) G.E. c660	G9	N74-d(.7d .7d)	Ceramic	0.5	4gr	30-20K	33-45
406	(m) RCA 74067 (Lan. Fill.)	A13	N560-1s	Crystal	0.8	10gr	50-6000	33-45
411d	(s) BSR sc7md-1	G11	N164-sd(.7d .7s)	HC Cer.	220MV	3gr	20-20K	33-45
413d	(s) BSR sc7md-2	G12	N164-sd(.7d .7s)	HC Cer.	220MV	3gr	20-20K	33-45
415d	(s) BSR sc7md-3	G13	N164-sd(.7d .7s)	HC Cer.	220MV	3gr	20-20K	33-45
417d	(s) BSR sc8hd-1	G11	N164-sd(.7d .7s)	Cer.	0.5	6gr	20-15K	33-45
419	(s) BSR sc8hd-2	G12	N164(.7s .7s)	Cer.	0.5	6gr	20-15K	33-45
419d	(s) BSR sc8hd-2	G12	N164-sd(.7d .7s)	Cer.	0.5	6gr	20-15K	33-45
420	(m) Adm. Sears	G15	N8-1s & 3s	Crystal	3.0	8gr	30-11K	ALL
421d	(s) BSR sc8hd-3	G13	N164-sd(.7d .7s)	Cer.	0.5	6gr	20-15K	33-45
427d	(s) BSR sc10ud-2	G12	N164-sd(.7d .7s)	Cer.	0.5	6gr	20-20K	33-45
428d	(s) BSR SC11M1/ST17	G11	N164-sd .7d .7s	Ceramic	0.6	6gr	40-15K	33-45
429d	(s) BSR sc12md	G45	N164-sd(.7d .7s)	Cer.	400MV	6gr	30-10K	33-45
431d	(s) BSR sc12hd	G45	N164-sd(.7d .7s)	Cer.	0.6	6gr	30-10K	33-45
434	(m) G.E. Show-Tell. Piezo	G16	N8-1s	Crystal	3.0	8gr	30-11K	33-45
459	(s) Magn. (2 scr.) 450246-1	G17	N50(.7s .7s)	Ceramic	0.55	4-6gr	20-15K	33-45
461	(s) Magn. (1 scr.) 560250-1	G18	N56(.7s .7s)	Ceramic	0.55	3gr	20-15K	33-45
461d	(s) Magn. (1 scr.) 560216-1	G18	N56-sd(.7d .7s)	Ceramic	0.55	3gr	20-15K	33-45
595d	(s) Zenith 142-167	G47	N883-sd(.7d .7s)	Ceramic	300MV	3gr	30-20K	33-45
597d	(s) Zenith 142-168	G46	N882-sd(.7d .7s)	Ceramic	300MV	3gr	30-20K	33-45
599d	(s) Zenith 142-182	G48	N884-Td (Turn.)	Ceramic	385MV	3gr	40-20K	33
602	(m) RCA 118187	G7	N78-7s	Crystal	2.7	8gr	30-10K	33-45
605	(s) Zen. 142-150	G41	N81(.7s .7s)	Ceramic	260MV	2-5gr	20-20K	33-45
605d	(s) Zen. 142-151	G41	N81-sd(.7d .7s)	Ceramic	260MV	2-5gr	20-20K	33-45
610	(s) B.S.R. sx1m, sx5m, tc	A6	N60(.7s .7s)	Crystal	1.0	6gr	30-15K	33-45
612	(s) B.S.R. sx5h,tc8	A6	N72(.7s .7s)	Crystal	2.0	8gr	30-10K	33-45
613	(s) RCA116931	G27	N84(.7s .7s)	Ceramic	330MV	3gr	20-20K	33-45
614	(m) B.S.R. ic8h, x1h	A6	N62(1s 1s)	Crystal	3.0	8gr	30-10K	33-45
624	(m) Channel Master. Imports	G49	N8-1s(1s)	Crystal	3.0	8gr	40-10K	33-45
645	(s) Magn. 560313-1	G28	N99-7s	Ceramic	350MV	5-7gr	20-20K	33-45
655d	(s) EV5015, Garrard. 30	G42	N89-sd(.7d .7s)	Ceramic	0.5	5-7gr	20-20K	33-45
664d	ACOS GP79	G52	PL(1d)	Ceramic	0.6	4gr	40-10K	33-45
665	(s) RCA 126316	G10	N84(.7s .7s)	Ceramic	350MV	4-6gr	20-20K	33-45
667	(s) B.S.R. sc5h, Airline	A23	N50 (.7s .7s)	Ceramic	0.5	4-6gr	20-15K	33-45
669d	(s) B.S.R. sc7hd, EV5545d	G31	N2-sd(.7d .7s)	Ceramic	210MV	3gr	20-20K	33-45
671	(s) Sears 33-470-0	G32	N89(.7s .7s)	Ceramic	250MV	6gr	30-15K	33-45
683	CEC	G53	N175-1s	Ceramic	350MV	4gr	40-10K	33-45
683d	CEC	G53	N175-7d	Ceramic	350MV	4gr	40-10K	33-45
710d	(s) Eup. u2, air1, VM	E1	N326-7d & 3s	Ceramic	0.5	2-6gr	30-15K	ALL
711d	(s) Eup. u4, Magn. 560275	E2	N326-7d & 3s	Ceramic	0.5	2-6gr	30-15K	ALL
718d	(s) Eup. u11, VM, Westing	E6	N425-sd(.7d .7s)	Ceramic	400MV	1.5-4gr	30-20K	33-45
719d	(s) Eup. u11r, Air1, Phonola	E7	N425-sd(.7d .7s)	Ceramic	400MV	3-6gr	30-20K	33-45
727	(s) Eup. u12, Adm., Vm	E8	N427(.7s .7s)	Ceramic	200MV	1-3gr	30-20K	33-45
728	(s) Eup. u12-5, Adm., Westing	E8	N427(.7s .7s)	HC Cer.	150MV	1-3gr	30-20K	33-45
728d	(s) Eup. u13-5, Adm.	E8	N427-sd(.7d .7s)	HC Cer.	150MV	3-6gr	30-20K	33-45
735d	(s) Eup. u19-14, Emer	E9	N429-sd(.7d .7s)	HC Cer.	150MV	6-10gr	30-20K	33-45
751e	(m) Sono. 2ta-sd, Phil.	S1	N874-sd(1d 1s)	Ceramic	1.0	8-10gr	20-20K	33-45
753	(m) Sono. 3t-s, Phil.	S3	N871(1s 1s)	Ceramic	0.5	8-10gr	20-20K	33-45
754d	(s) Sono. 8ta-4-sd, Adm., West	S4	N876-sd(.7d .7s)	Ceramic	300MV	4-6gr	20-20K	33-45
760d	(s) Sono. 16af-sd, Phil.	S8	N885-sd(.7d .7s)	Ceramic	0.5	5-7gr	20-20K	33-45
762	(s) Sono. 18ta-s, Sears	S6	N888(.7s .7s)	Ceramic	0.5	5-7gr	20-20K	33-45
772d	(s) Panasonic. EPC34 T1CD	S10	N160-sd(.7d .7s)	Ceramic	300MV	6gr	20-15K	33-45
TK-1	(See Page 5)							
TK-2	(See Page 5)							
TK-7	(See Page 5)							
1101d	(s) Tetr. 1-T1Ld-m1 (Black)	T1	N730-sd(.7d .7s)	Ceramic	250MV	3gr	30-20K	33-45
1102d	(s) Tetr. 1-T3md-m2 (Black)	T1	N732-sd(.7d .7s)	Ceramic	450MV	5gr	30-20K	33-45
1105d	(s) Tetr. 1-T2md-bsr15 (Black)	T3	N734-sd(.7d .7s)	Ceramic	320MV	3.5gr	30-20K	33-45
1107d	(s) Tetr. 1-T2md-g3 (Black)	T4	N736-sd(.7d .7s)	Ceramic	320MV	3.5gr	30-20K	33-45
1109	(s) Tetr. 1-T3md-a (Black)	T5	N794(.7s .7s)	Ceramic	0.64	7gr	30-20K	33-45
1110d	(s) Tetr. 1-T1Ld-b (Black)	T5	N806-sd(.7d .7s)	Ceramic	250MV	4gr	30-20K	33-45
1111d	(s) Tetr. 2-T1Ld-u4 (Blue)	T6	N792-7d	Ceramic	240MV	3gr	30-20K	33-45
1113d	(s) Tetr. 2-T1Ld-s2 (Blue)	T8	N730-sd(.7d .7s)	Ceramic	240MV	3gr	30-20K	33-45
1115d	(s) Tetr. 2-T1Ld-a (Blue)	T5	N776-sd(.7d .7s)	Ceramic	240MV	3gr	30-20K	33-45
1116d	(s) Tetr. 2-T1Ld-sn2 (Blue)	T18	N772-sd(.7d .7s)	Ceramic	240MV	3gr	30-20K	33-45
1117d	(s) Tetr. 2-T3md-bsr2 (Blue)	T10	N732-sd(.7d .7s)	Ceramic	410MV	5gr	30-20K	33-45
1118d	(s) Tetr. 2-T3md-bsr4 (Blue)	T3	N732-sd(.7d .7s)	Ceramic	410MV	5gr	30-20K	33-45
1119d	(s) Tetr. 2-T3md-v6 (Blue)	T9	N732-sd(.7d .7s)	Ceramic	410MV	5gr	30-20K	33-45
1122d	(s) Tetr. 2-T3md-p5 (Blue)	T12	N774-sd(.7d .7s)	Ceramic	340MV	4gr	30-20K	33-45
1125d	(s) Tetr. 2-T5hd-rt1 (Blue)	T11	N782-sd(.7d .7s)	Ceramic	0.52	6.5gr	30-20K	33-45
1126	(s) Tetr. 2-T5hs-m10 (Blue)	T14	N782(.7s .7s)	Ceramic	0.52	6.5gr	30-20K	33-45
1128d	(s) Tetr. 2-T5hs-bsr11 (Blue)	T10	N784-sd(.7d .7s)	Ceramic	0.60	7gr	30-20K	33-45
1129d	(s) Tetr. 2-T5hd-sn1 (Blue)	T16	N786-sd(.7d .7s)	Ceramic	0.60	7gr	30-20K	33-45

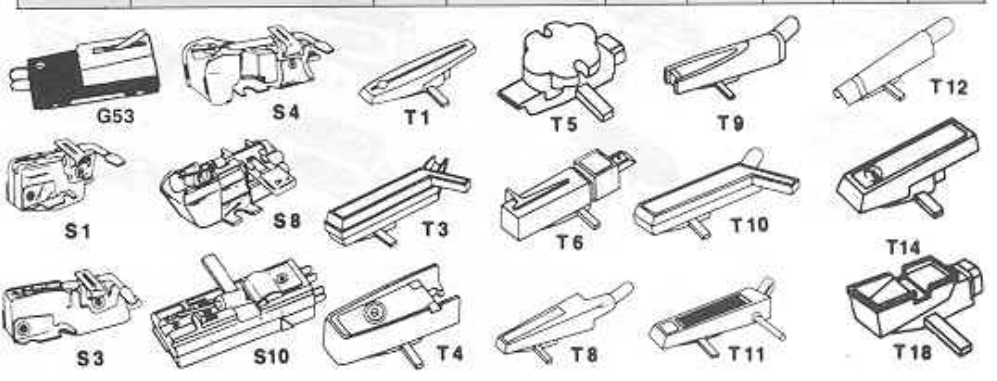
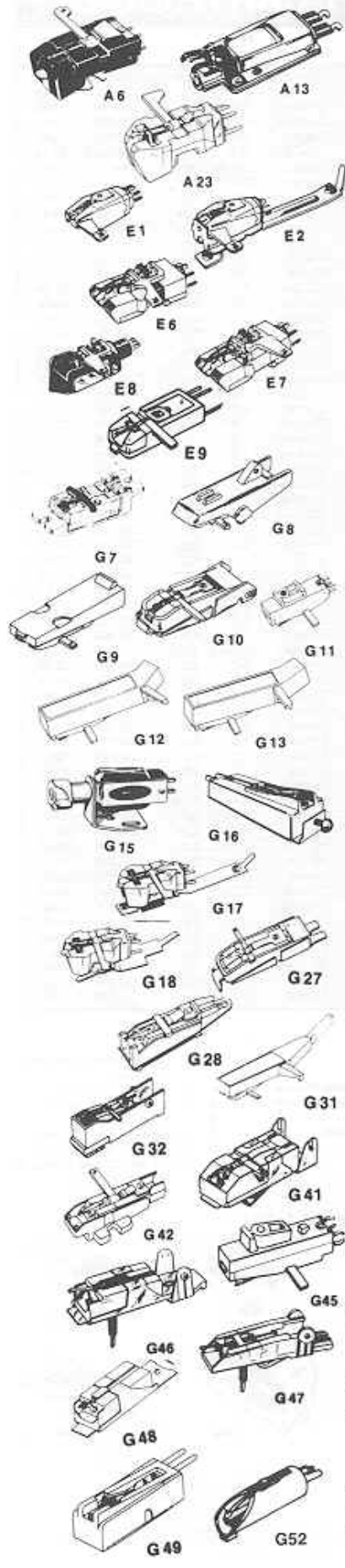

# ASTATIC PHONOGRAPH CARTRIDGES

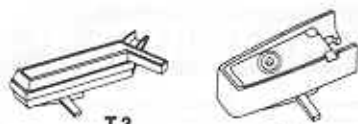

T3

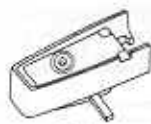

T4



T5

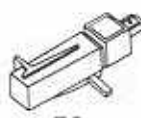

T6



T8



T9



T10



T11



T12



T13



T15



T16

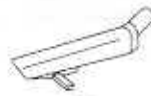

T17

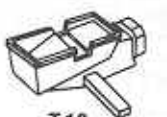

T18



T20



T22

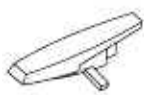

T25

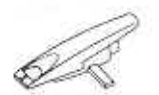

T26



T28



T29

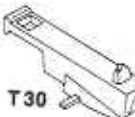

T30



T32

Cartridge Number	Used in or Replacement for	Figure	ASTATIC Needle	Element	Volts Output	FREQ. RANGE	SPEED
1134d (s)	Tetr. 2-T3md-244-1 (Blue)	T5	N796-sd(7d .7s)	Ceramic	360MV 5.5gr.	30-20K	33-45
1135 (s)	Tetr. 2-T3ms-dc3 (Blue)	T15	N796(.7s .7s)	Ceramic	360MV 5.5gr.	30-20K	33-45
1136 (s)	Tetr. 2-T3ms-dc2 (Blue)	T15	N802(.7s .7s)	Ceramic	360MV 4.5gr.	30-20K	33-45
1139d (s)	Tetr. 3-T1Ld-a2 (Gray)	T11	N730-sd(.7d .7s)	HC Cer.	150MV 3gr.	30-20K	33-45
1140d (s)	Tetr. 3-T1Ld-s11 (Gray)	T8	N730-sd(.7d .7s)	HC Cer.	150MV 3gr.	30-20K	33-45
1141 (s)	Tetr. 3-T1Ls-p6 (Gray)	T13	N802(.7s .7s)	Ceramic	150MV 3gr.	30-20K	33-45
1144d (s)	Tetr. 3-T3md-bsr16 (Gray)	T3	N774-sd(.7d .7s)	HC Cer.	220MV 4gr.	30-20K	33-45
1146d (s)	Tetr. 3-T3md-p8 (Gray)	T12	N774-sd(.7d .7s)	HC Cer.	220MV 4gr.	30-20K	33-45
1147d (s)	Tetr. 3-T3md-p13 (Gray)	T17	N774-sd(.7d .7s)	HC Cer.	220MV 4gr.	30-20K	33-45
1150d (s)	Tetr. 3-T3md-s (Gray)	T5	N780-sd(.7d .7s)	HC Cer.	220MV 4gr.	30-20K	33-45
1151d (s)	Tetr. 14-T2md-sn4 (Orange)	T18	N736-sd(.7d .7s)	HC Cer.	220MV 4gr.	30-20K	33-45
1152d (s)	Tetr. 3-T1Ld-bsr9 (Gray)	T10	N782-sd(.7d .7s)	HC Cer.	340MV 6.5gr.	30-20K	33-45
1154d (s)	Tetr. 3-T5hd-cm1 (Gray)	T20	N738-sd(.7d .7s)	HC Cer.	340MV 6.5gr.	30-20K	33-45
1155d (s)	Tetr. 3-T5hd-a (Gray)	T5	N798-sd(.7d .7s)	HC Cer.	380MV 7gr.	30-20K	33-45
1158d (s)	Tetr. 3-T11d-v43 (Gray)	T16	N804-sd(.7d .7s)	HC Cer.	140MV 4gr.	30-20K	33-45
1161d (s)	Tetr. 5-T3md-301-1 (Yellow)	T22	N774-sd(.7d .7s)	HC Cer.	220MV 4gr.	30-20K	33-45
1162d (s)	Tetr. 5-T3md-b (Yellow)	T5	N780-sd(.7d .7s)	HC Cer.	220MV 4gr.	30-20K	33-45
1163d (s)	Tetr. 5-T3md-27-2 (Yellow)	T18	N780-sd(.7d .7s)	HC Cer.	220MV 4gr.	30-20K	33-45
1164d (s)	Tetr. 5-T3md-g1 (Yellow)	T4	N780-sd(.7d .7s)	HC Cer.	220MV 4gr.	30-20K	33-45
1165d (s)	Tetr. 5-T5hd-142-154 (Yellow)	T5	N798-sd(.7d .7s)	HC Cer.	370MV 7gr.	30-20K	33-45
1166d (s)	Tetr. 6-T1Ld-u2 (Red)	T6	N792-7d(.7d)	HC Cer.	100MV 3gr.	30-20K	33-45
1167d (s)	Tetr. 6-T1Ld-bsr6 (Red)	T10	N730-sd(.7d .7s)	HC Cer.	100MV 3gr.	30-20K	33-45
1170 (s)	Tetr. 6-T1Ls-p1 (Red)	T13	N730(.7s .7s)	HC Cer.	100MV 3gr.	30-20K	33-45
1170d (s)	Tetr. 6-T1Ld-p2 (Red)	T13	N730-sd(.7d .7s)	HC Cer.	100MV 3gr.	30-20K	33-45
1171d (s)	Tetr. 6-T1Ld-p10 (Red)	T17	N730-sd(.7d .7s)	HC Cer.	100MV 3gr.	30-20K	33-45
1175d (s)	Tetr. 6-T7Ld-99-2 (Red)	T18	N800-sd(.7d .7s)	HC Cer.	100MV 3gr.	30-20K	33-45
1179d (s)	Tetr. 6-T3md-s5 (Red)	T8	N732-sd(.7d .7s)	HC Cer.	175MV 5gr.	30-20K	33-45
1181d (s)	Tetr. 6-T3md-v7 (Red)	T9	N732-sd(.7d .7s)	HC Cer.	175MV 5gr.	30-20K	33-45
1182d (s)	Tetr. 6-T3md-b (Red)	T5	N778-sd(.7d .7s)	HC Cer.	175MV 5gr.	30-20K	33-45
1183d (s)	Tetr. 6-T3md-g4 (Red)	T4	N778-sd(.7d .7s)	HC Cer.	175MV 5gr.	30-20K	33-45
1184 (s)	Tetr. 6-T3md-sn2 (Red)	T18	N778(.7s .7s)	HC Cer.	175MV 5gr.	30-20K	33-45
1185d (s)	Tetr. 6-T2md-m3 (Red)	T25	N734-sd(.7d .7s)	HC Cer.	125MV 3.5gr.	30-20K	33-45
1187d (s)	Tetr. 6-T2md-m8 (Red)	T26	N734-sd(.7d .7s)	HC Cer.	125MV 3.5gr.	30-20K	33-45
1190d (s)	Tetr. 6-T2md-75-1 (Red)	T5	N770-sd(.7d .7s)	HC Cer.	125MV 3.5gr.	30-20K	33-45
1191d (s)	Tetr. 6-T2md-235-1 (Red)	T18	N736-sd(.7d .7s)	HC Cer.	125MV 3.5gr.	30-20K	33-45
1195d (s)	Tetr. 6-T3md-bsr3 (Red)	T10	N774-sd(.7d .7s)	HC Cer.	150MV 4gr.	30-20K	33-45
1196d (s)	Tetr. 6-T3md-bsr6 (Red)	T3	N774-sd(.7d .7s)	HC Cer.	150MV 4gr.	30-20K	33-45
1198d (s)	Tetr. 6-T5hd-bsr17 (Red)	T3	N782-sd(.7d .7s)	HC Cer.	225MV 6.5gr.	30-20K	33-45
1199d (s)	Tetr. 6-T5hd-a (Red)	T5	N738-sd(.7d .7s)	HC Cer.	225MV 6.5gr.	30-20K	33-45
1201d (s)	Tetr. 6-T7Ld-p4 (Red)	T12	N798-sd(.7d .7s)	HC Cer.	80MV 2.5gr.	30-20K	33-45
1203d (s)	Tetr. 6-T5hd-a (Red)	T5	N794-sd(.7d .7s)	HC Cer.	250MV 5gr.	30-20K	33-45
1206d (s)	Tetr. 6-T3md-sn3 (Red)	T18	N798-sd(.7d .7s)	HC Cer.	160MV 5.5gr.	30-20K	33-45
1211d (s)	Tetr. 2-T1Ld-n2 (Blue)	T28	N792-7d	Ceramic	240MV 3gr.	30-20K	33-45
1213d (s)	Tetr. 2-T1Ld-bsr31 (Blue)	T22	N774-sd(.7d .7s)	Ceramic	340MV 4gr.	30-20K	33-45
1218d (s)	Tetr. 2-T3hd-c (Blue)	T5	N808-sd(.7d .7s)	Ceramic	0.5 7.5gr.	30-20K	33-45
1224d (s)	Tetr. 3-T5hd-v25 (Gray)	T16	N782-sd(.7d .7s)	HC Cer.	340MV 6.5gr.	30-20K	33-45
1225d (s)	Tetr. 3-T7Ld-ss4 (Gray)	T29	N798-sd(.7d .7s)	HC Cer.	120MV 2.5gr.	30-20K	33-45
1228d (s)	Tetr. 3-T3md-ar5 (Gray)	T22	N798-sd(.7d .7s)	HC Cer.	270MV 5.5gr.	30-20K	33-45
1229d (s)	Tetr. 3-T2md-244-5 (Gray)	T5	N802-sd(.7d .7s)	HC Cer.	220MV 4.5gr.	30-20K	33-45
1231d (s)	Tetr. 5-T3md-301-5 (Yellow)	T22	N774-sd(.7d .7s)	HC Cer.	220MV 4gr.	30-20K	33-45
1234d (s)	Tetr. 6-T1Ld-n1 (Red)	T28	N792-7d	HC Cer.	100MV 3gr.	30-20K	33-45
1239d (s)	Tetr. 6-T5hd-bsr34 (Red)	T22	N782-sd(.7d .7s)	HC Cer.	225MV 6.5gr.	30-20K	33-45
1250d (s)	Tetr. 2-T3md-235-5 (Blue)	T18	N780-sd(.7d .7s)	HC Cer.	340MV 4gr.	30-15K	33-45
1251d (s)	Tetr. 1-T5hd-bsr25 (Black)	T3	N782-sd(.7d .7s)	HC Cer.	0.57 6.5gr.	40-10K	33-45
1252d (s)	Tetr. 2-T1Ld-bsr49 (Blue)	T10	N730-sd(.7d .7s)	HC Cer.	240MV 3gr.	20-20K	33-45
1254d (s)	Tetr. 2-T5hd-111-17 (Blue)	T30	N794-sd(.7d .7s)	HC Cer.	0.56 8.5gr.	40-10K	33-45
1255d (s)	Tetr. 2-T1Ld-bsr36 (Blue)	T22	N730-sd(.7d .7s)	HC Cer.	3gr.	20-20K	33-45
1256d (s)	Tetr. 2-T1Ld-111-18 (Blue)	T30	N806-sd(.7d .7s)	HC Cer.	250MV 4gr.	30-15K	33-45
1257d (s)	Tetr. 14-T3md-753-1 (Orange)	T22	N774-sd(.7d .7s)	HC Cer.	280MV 4gr.	30-15K	33-45
1258d (s)	Tetr. 14-T1Ld-752-1 (Orange)	T22	N804-sd(.7d .7s)	HC Cer.	200MV 4gr.	30-15K	33-45
1259d (s)	Tetr. 2-T5hd-bsr44 (Blue)	T22	N804-sd(.7d .7s)	HC Cer.	0.5 7.5gr.	40-10K	33-45
1261 (s)	Tetr. 2-T5hs-111-3 (Blue)	T32	N796(.7s .7s)	HC Cer.	0.5 7.5gr.	40-10K	33-45

## LEGEND

- (ed) — Elliptical—33½ (stereo)
- (n) — New since C-80 Cartridge Catalog
- (qd) — 4-Channel
- (s) — Stereo
- (m) — Monaural
- S — Precision Polished Synthetic Jewel Tip
- Td — Truncated
- D & X — Natural Diamond
- T — Turnover Cartridge
- TB — Turnover Cartridge with Bracket
- TX — Turnover Cartridge with Formed Yoke
- TS — Turnover Cartridge with Rounded Spindle
- PL — Plug-in Cartridge
- \* — Needle not included with Cartridge
- 1 — 1 Mil. 33½-45 RPM
- 2 — 2 Mil. 33½-45-78 RPM
- 3 — 3 Mil. 78 RPM
- 5 — 0.5 Mil.—33½ (Stereo)
- 6 — 0.6 Mil.—33½ (Stereo)
- 7 — 0.7 Mil.—33½-45 (Stereo or Monaural)

For Astatic Models Not Listed Here Refer to pages 5, 6, and 7.



T28



T29



A4

Pak #2 consists of 5 MB#2 stereo mounting brackets for 11T7, 13T, 13TX, 13AT, 13ATX.

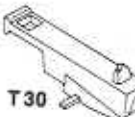

T30



T32



A21

Pak #3 consists of 5 MB#3 monaural mounting brackets for 81T, 81TX, 89T, 89TX. List Price

## Hardware Paks

Pak #7 consists of 25 Tetrads Plugs

Pak #11 consists of 6 different knobs, related screws and springs widely used by Astatic and other manufacturers.